

FALLPROTEC

Height Safety Products

+352 26 55 09 30 | www.fallprotec.com



FALLPROTEC
FOR OIL & GAS



📍 Vlissingen Port, Netherlands

RISKS ON OIL & GAS PLATFORMS AND LOADING BAYS

Fall events are one of the leading causes of death in the oil and gas extraction industry. Workers might be required to access platforms and equipment located high above the ground. The work demands fall protection to prevent falls from the mast, drilling platform, and other elevated equipment like pedestal cranes. Work in confined spaces is also required, as petroleum and other storage tanks. At the loading bay, workers need to climb on platforms and trucks to manipulate a piping or hose arrangement for filling the tank on the truck.

Source:
<https://www.osha.gov/SLTC/oilgaswelldrilling/safetyhazards.html#falls>

If there is no collective protection to eliminate the risk of falling, workers must be provided with and trained in the use of appropriate fall protection equipment, such as lifelines and EPIs. Likewise, an appropriate and timely rescue should be provided to prevent suspension trauma.

- **SecuRail Pro Inclined (p. 4)**
- **SecuRope Horizontal (p. 6)**
- **SecuRope Vertical (p. 8)**
- **SafeAccess fall arrest (p. 10)**
- **Davit arm and Tripod (p. 12)**
- **Self retractable lanyard (p. 15)**

● **Confined spaces:
All over the platform**

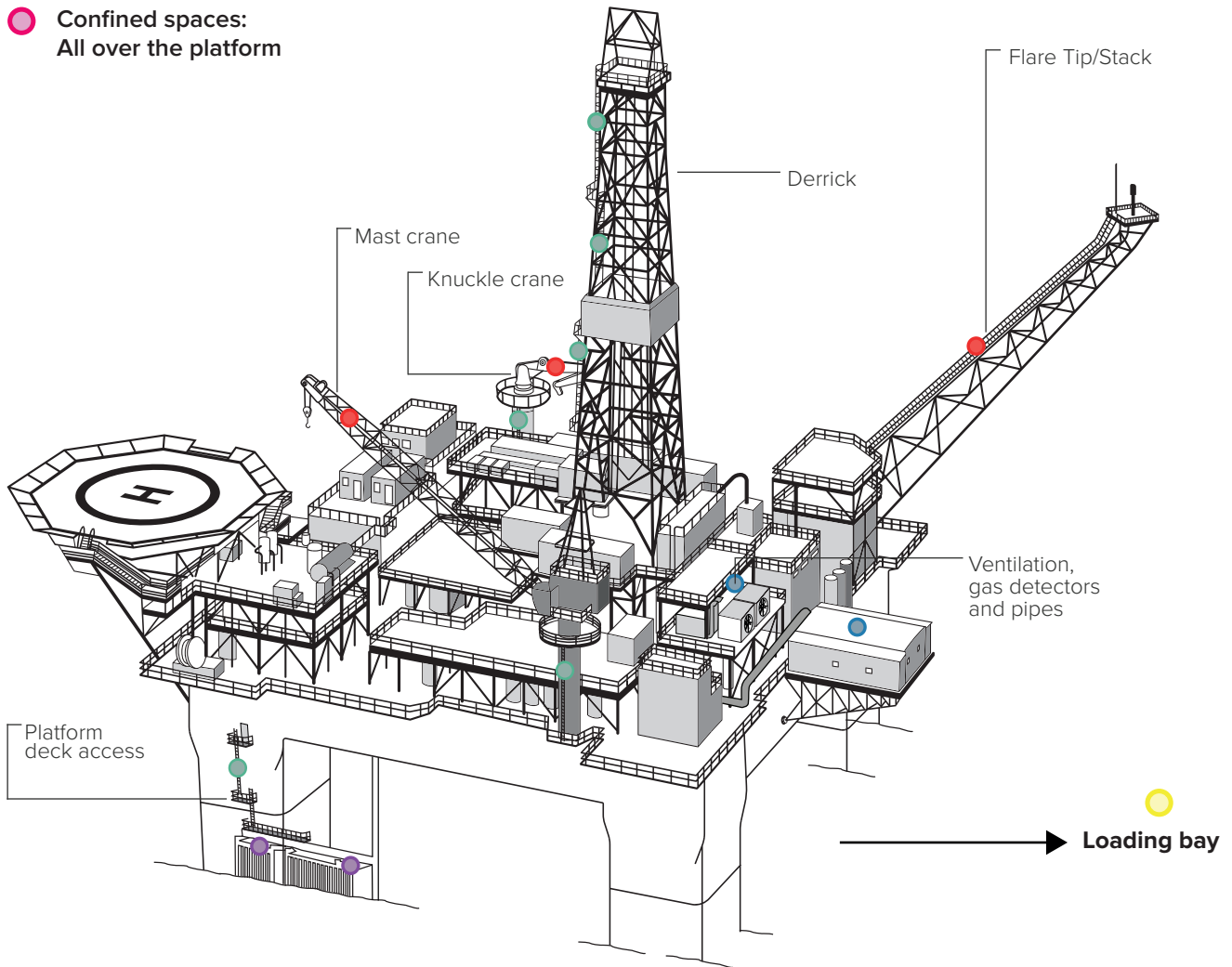

CHOOSING FALLPROTEC MEANS

- One reference for global assistance
- Certified by independent notifying bodies as per latest European
- Quality control: ISO9001:2015. E.C. Quality of Production « Article 11B »
- Product liability insurance
- Warranty
- One-Stop-Shop

Maintenance of Flare tip/Stack and mobile cranes

Oil and gas extraction workers may be exposed to a wide variety of rotating wellhead equipment, including top drives and Kelly drives, drawworks, pumps, compressors, catheads, hoist blocks, belt wheels, and conveyors, and might be injured if they are struck by or caught between unguarded machines.

The Securail Pro is a cost-efficient solution for this situation, as the same trolley can be used for applications on ground, wall or ceiling. With its low deflection and easy passage, it is a key companion for oil & gas industries that include a lot of walkways between or above machines.

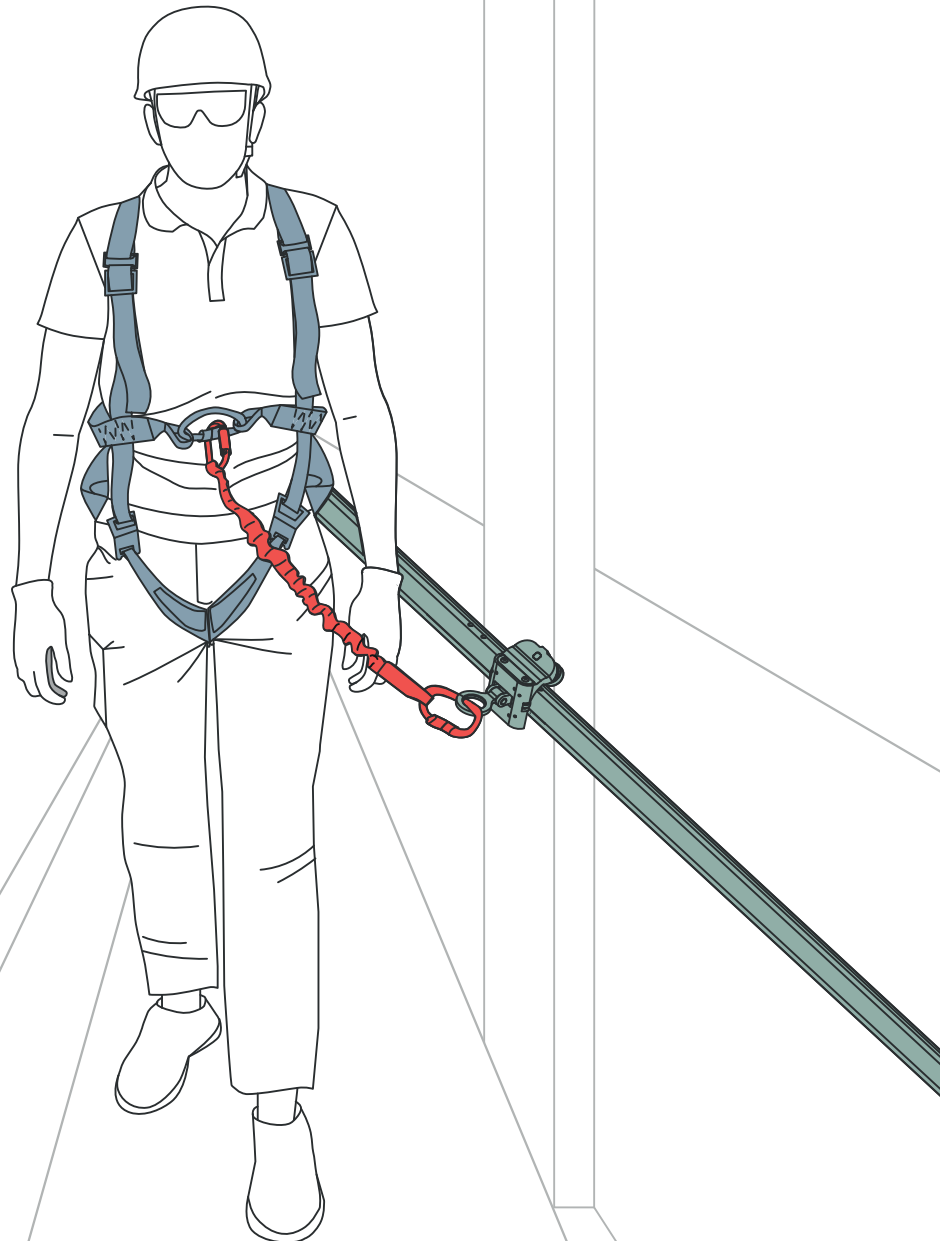

Oil & gas applications have a low fall clearance due to the strong presence of machinery below the walkways. Fallprotec recommends installations with fall factors ≈ 0 (overhead)

SecuRail Pro lifeline on ground or wall, configuration with a GRANVIA trolley RHF511. The wall configuration is often used in the oil & gas industry due to low fall clearance. Made of high resistance aluminium, the rail can be easily used in environments that are highly corrosive such as for instance maritime oil platforms.

[Click here to visit the online product page](#)

EN795:2012 Type D | CEN/TS16415:2013



x 2

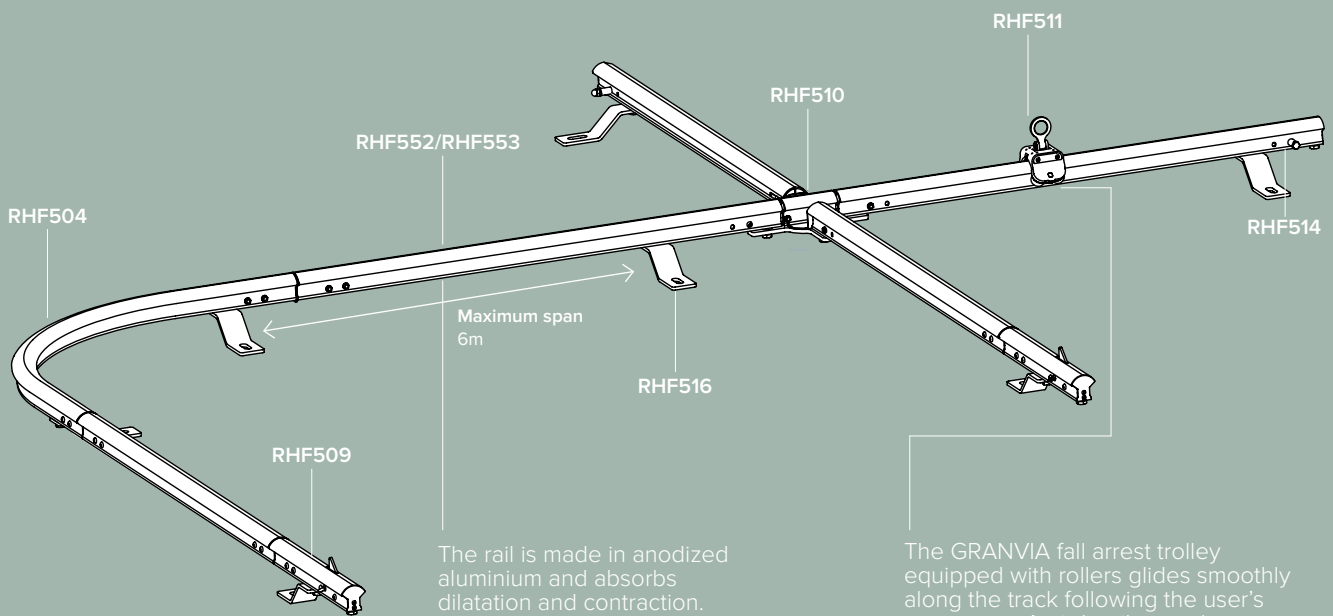

The rail is made in anodized aluminium and absorbs dilatation and contraction. Low deflection after activation.

The GRANVIA fall arrest trolley equipped with rollers glides smoothly along the track following the user's movement. Anti-derailment claws mounted between the rollers keep the trolley firmly on the track. The same trolley is used for ground, wall and ceiling configuration. The rollers enable a smooth gliding of the trolley.

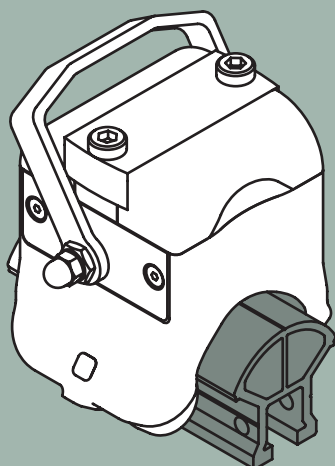

Overspeed Trolley

The new multidirectional trolley works either for inclined and horizontal lifelines. This allows the assembly of horizontal lifelines with sloped sections, all in one, avoiding the user's disconnection. Equipped with shock absorber, the installation is easy, directly on the rail.

Maintenance of machinery, fire and gas detectors

Oil and gas extraction workers may be exposed to a wide variety of rotating wellhead equipment, including top drives and Kelly drives, drawworks, pumps, compressors, catheads, hoist blocks, belt wheels, and conveyors, and might be injured if they are struck by or caught between unguarded machines.

The Securope is usable in all kinds of oil&gas configuration. Indeed, it offers a wide range of gliders for all configurations as well as fixing assemblies designed for various support types.

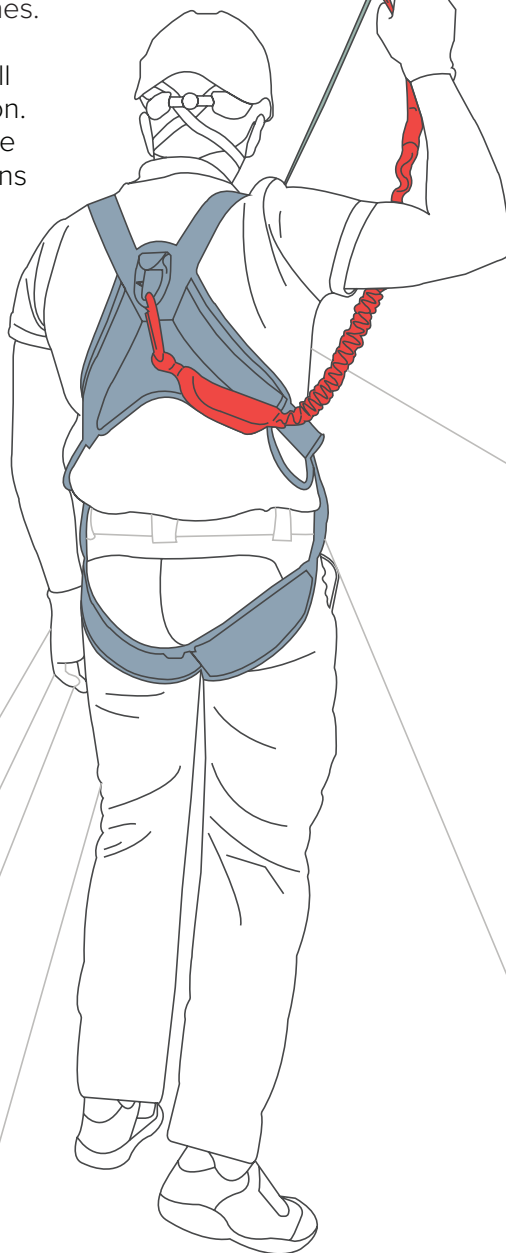

Oil & gas facilities have a low fall clearance due to the strong presence of machinery below the walkways. Fallprotec recommends installations with fall factors ≈ 0 (overhead)

SecuRope lifeline on wall configuration with glider LDV133. The wall overhead configuration is the most used in oil & gas industry. For this type of configuration Fallprotec suggests the cable LDV005 construction 1x19 and \varnothing 8mm which reduces even more the deflection of the cable and thanks to its properties it is more resistant than others to high corrosive environments.

[Click here to visit the online product page](#)

EN795:2012 Type C CEN/TS16415:2013



x 4
(2 users max. per span)

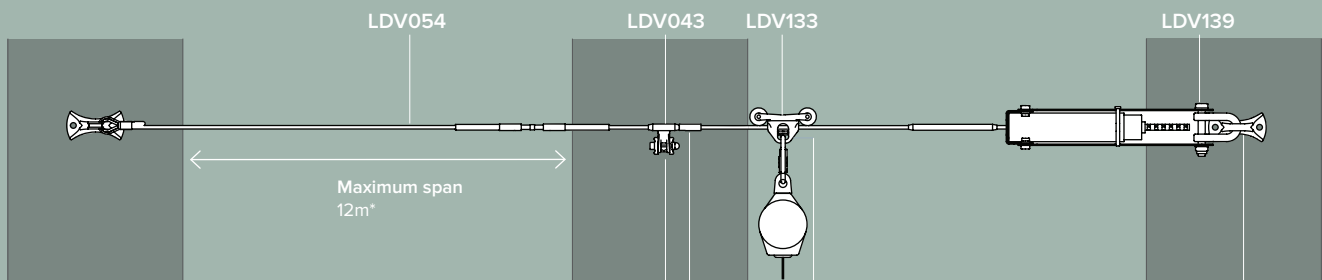

The cable guide located on a plan forming angle of 45° with the horizontal plane increases the absorbing-energy asset of the system protecting the roof.

Thanks to the cable crimping technology, the cable deflection is reduced in order to stop the fall in the shortest distance possible.

The LDV133 is the proper glider when the connecting device is a self-retractable fall arrester that weights 10 kg or less. The glider passes smoothly over the intermediate anchors. The end user can move freely along the lifeline without disconnecting and hands-free to operate with tools. If the user is less than 3 m below the life line, 2 m absorbing lanyard, connects the user to the captive glider LDV060.

With its integrated energy absorbing mechanism, it reduces the load transmitted to the host structure.

*For longer spans contact the Fallprotec's engineering department

Access to the derrick, mobiles cranes and the platform deck

Oil & gas extraction facilities require a lot of moving from one level to the next. They therefore have a high risk of falls from height while moving upwards. Specifically, off-shore plants submit their workers to harsh weather conditions including a lot of wind. For this, the Securope vertical is an easy solution, allowing also the user to choose when to connect or disconnect on the lifeline.

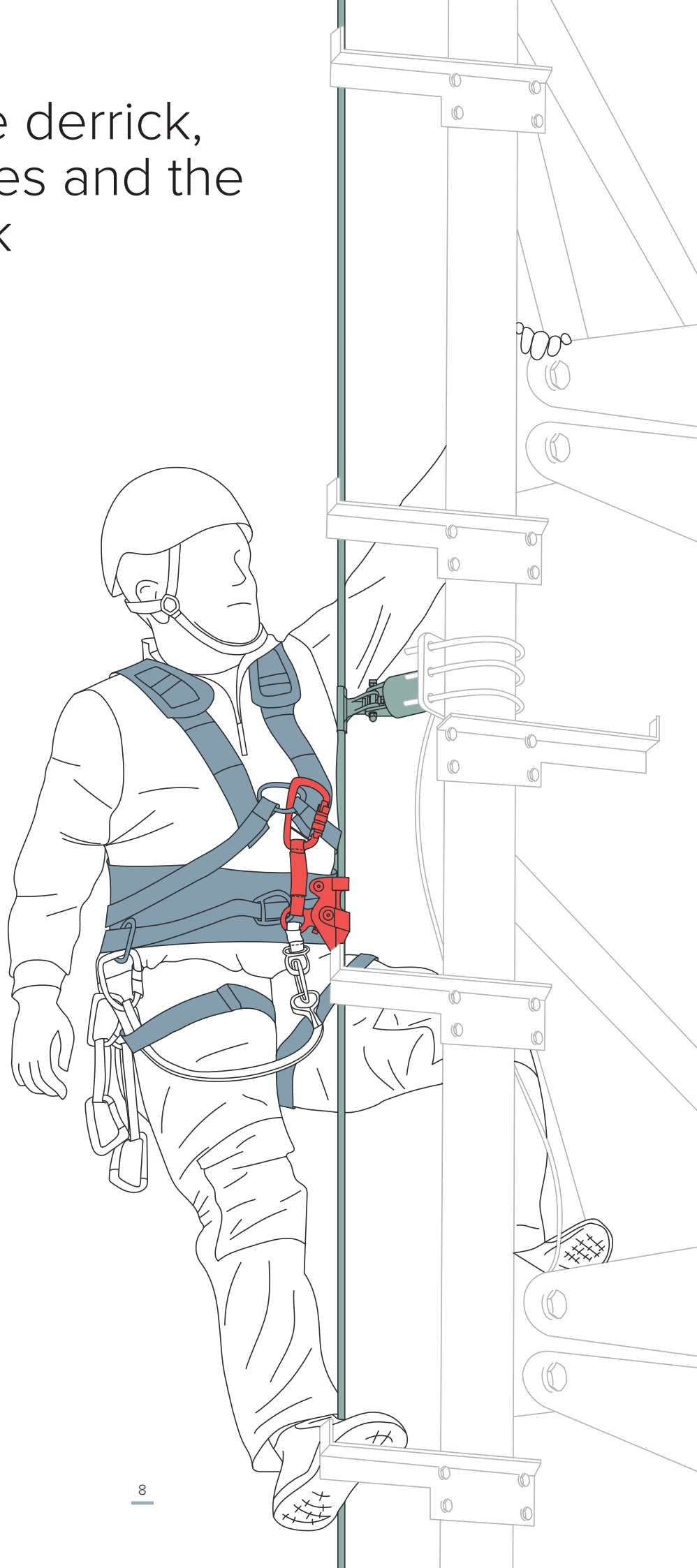

Oil & gas facilities have a high risk of fall as the workers are exposed to winds during their work. Fallprotec 's products keep the worker close to the structure.

Fallprotec provides a vertical cable lifeline Securope. It can indeed be retrofitted on an existing ladder or structure. Installed without crimping, it comes with an opening glider that allows the user to keep safely connected while being capable to connect to the lifeline a whichever time he wishes. The glider blocks automatically in case of a fall. Fallprotec suggests the use of the cable LDV005 construction 1x19 and \varnothing 8mm as it reduces even more the deflection of the cable. It is also more resistant than others to high temperature conditions and corrosive environments.

 [Click here to visit the online product page](#)

EN353-1:2014 | PPE Regulation 2016/425



x 4
(with absorber on the glider)

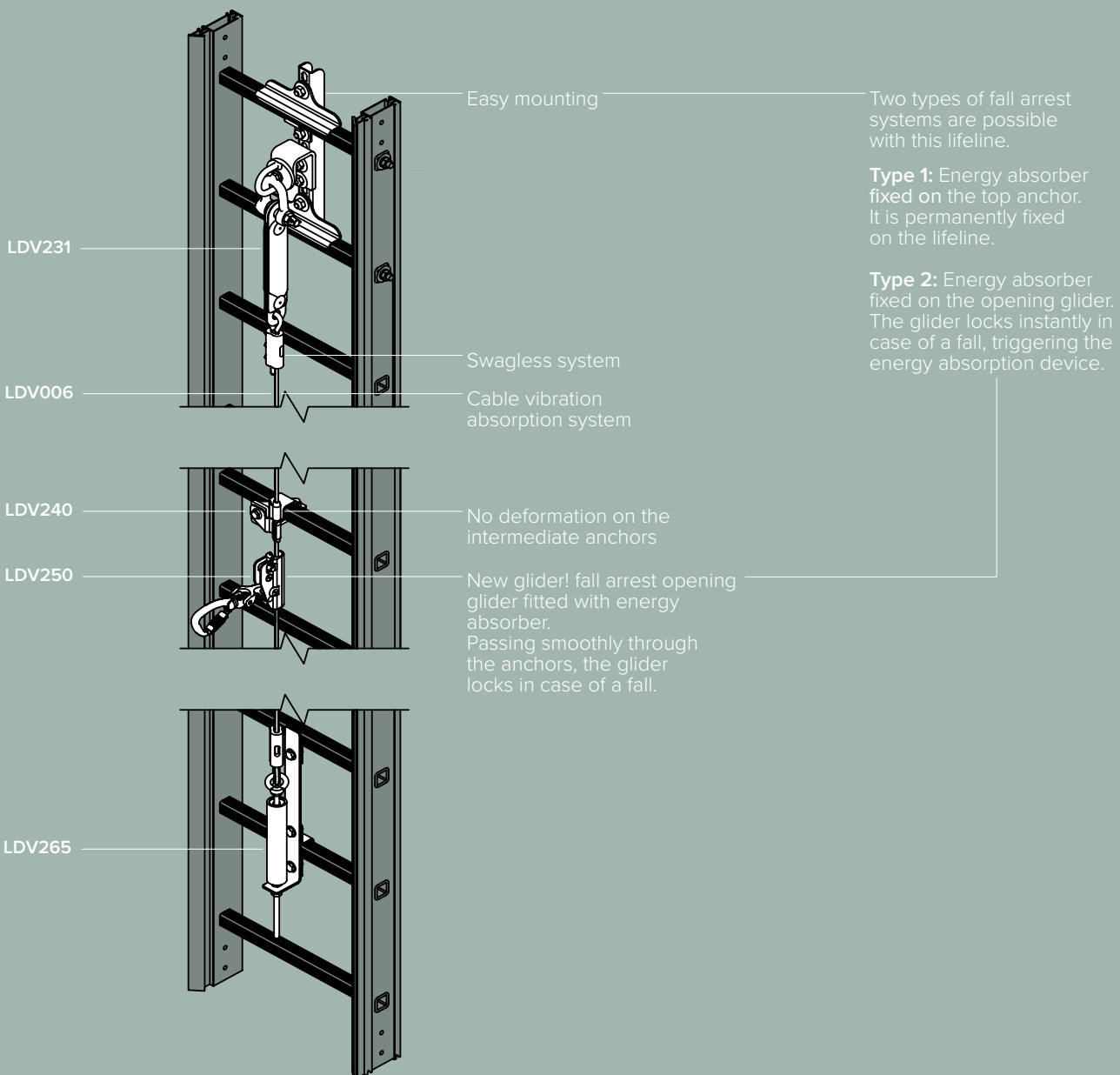

Loading tanker trucks

Trucks can be loaded from the above. Workers have to place themselves at height in order to control the filling of the tank. Risks include the inhalation of toxic products and falls from height. In order to secure workers performing this task, Fallprotec provides safety ATEX equipments.

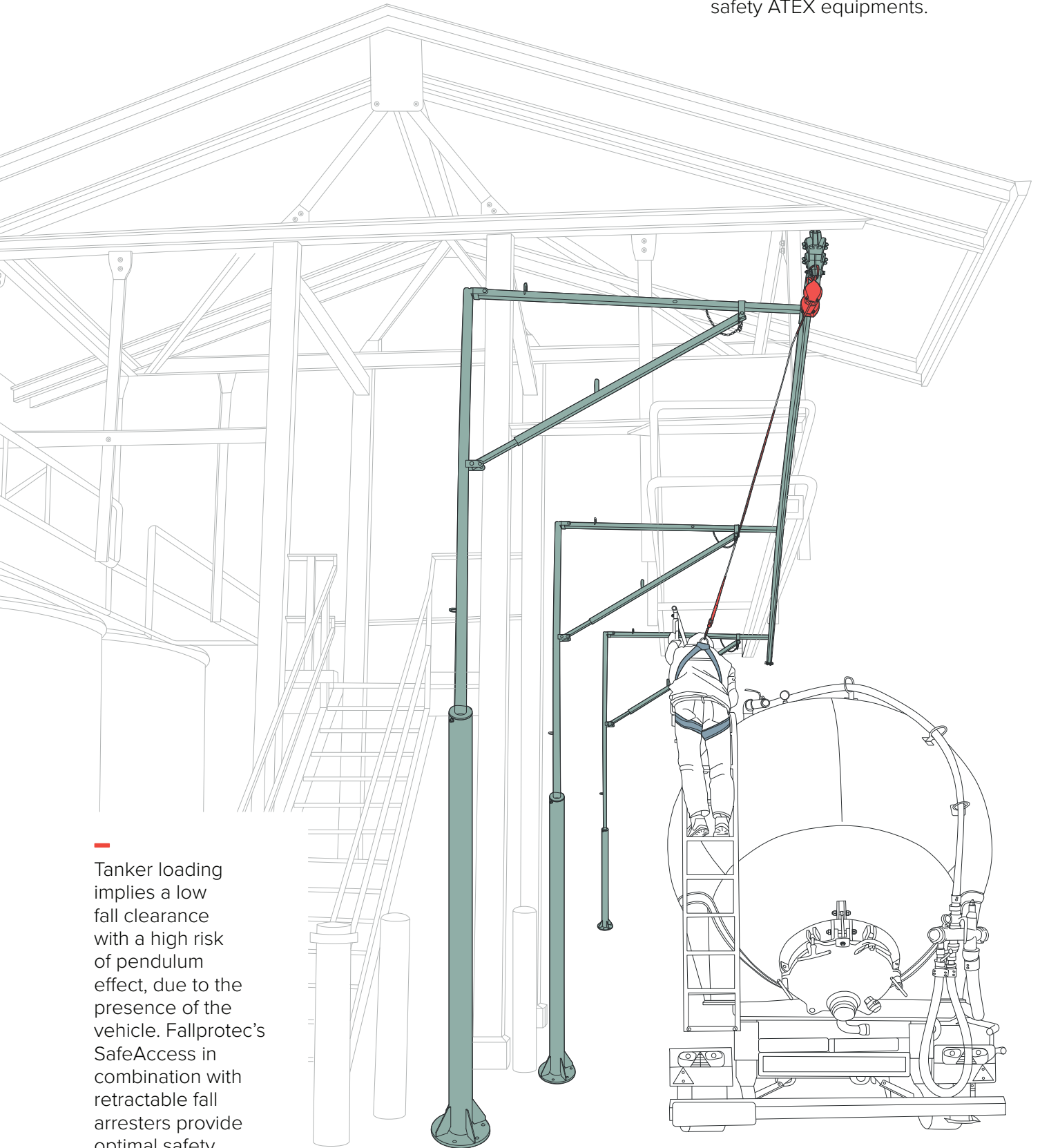

— Tanker loading implies a low fall clearance with a high risk of pendulum effect, due to the presence of the vehicle. Fallprotec's SafeAccess in combination with retractable fall arresters provide optimal safety.



Click here to visit the online product page

The SafeAccess monorail of Fallprotec can be used in many combinations: ground, wall, ceiling or jibs above a loading bay. The robust design suits intensive applications, the rail remains usable years after being installed. In case of a fall, it is one of the very few systems where there will be no need to replace any part. Combined with a safety block enables the safest possible fall arrest.

EN795:2012 Type D | CEN/TS16415:2013 | EN1808:2015



X 4
(2 users with Flexbow)



apave

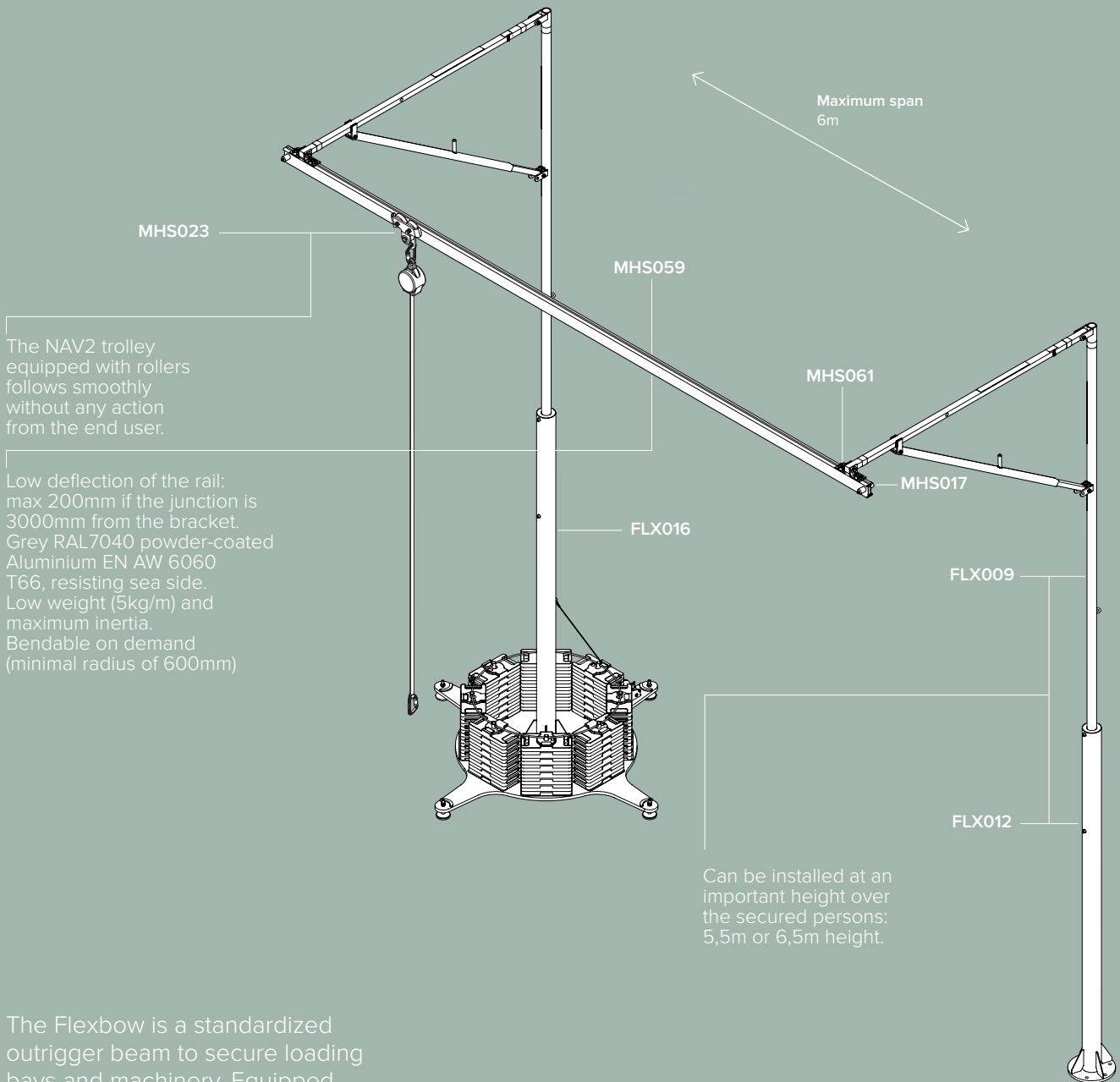

The Flexbow is a standardized outrigger beam to secure loading bays and machinery. Equipped with an integrated energy absorber, it is a lightweight and yet robust design for industrial applications with a minimum fall clearance of 4m. Several configurations (mobile, fixed on ground, fixed on wall...) are available.

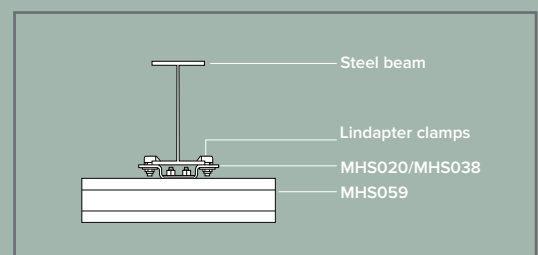

Access to storage tanks, mud pits, reserve pits and storage containers

Workers are often required to enter confined spaces such as petroleum and other storage tanks, mud pits, reserve pits and other excavated areas, sand storage containers, and other confined spaces around a wellhead. Safety hazards associated with confined space include falls, asphyxiation and exposure to hazardous chemicals.

Workers must not be allowed to enter such spaces unless proper training, equipment and procedures are in place. A confined space must be evaluated to determine if it is a permit-required space.

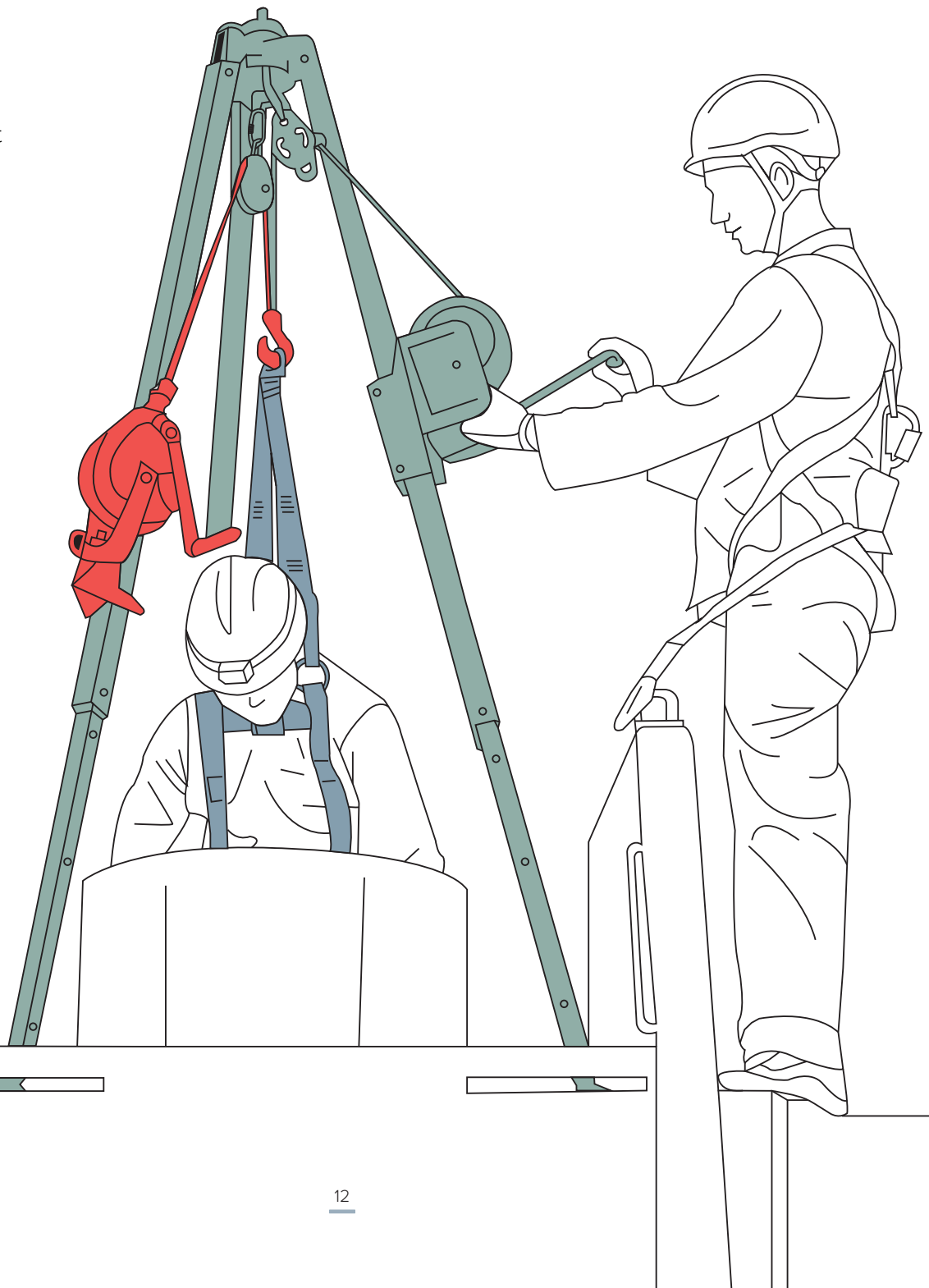

Davit arms and tripods are used to enhance the safety whilst entering, escaping, and accessing confined spaces. Rescue missions can be performed effectively by winching an injured person in a harness to safety. Fallprotec's davits and tripods made in AISI304 has been specially developed for mobile use in conjunction with the RopeClimber hoist, HRA Rescue device and winches.

[Click here to visit the online product page](#)

EN795:2012 Type B | CEN/TS16415:2013 | EN1808:2015



x 1



apave

Davit arm for access by rope

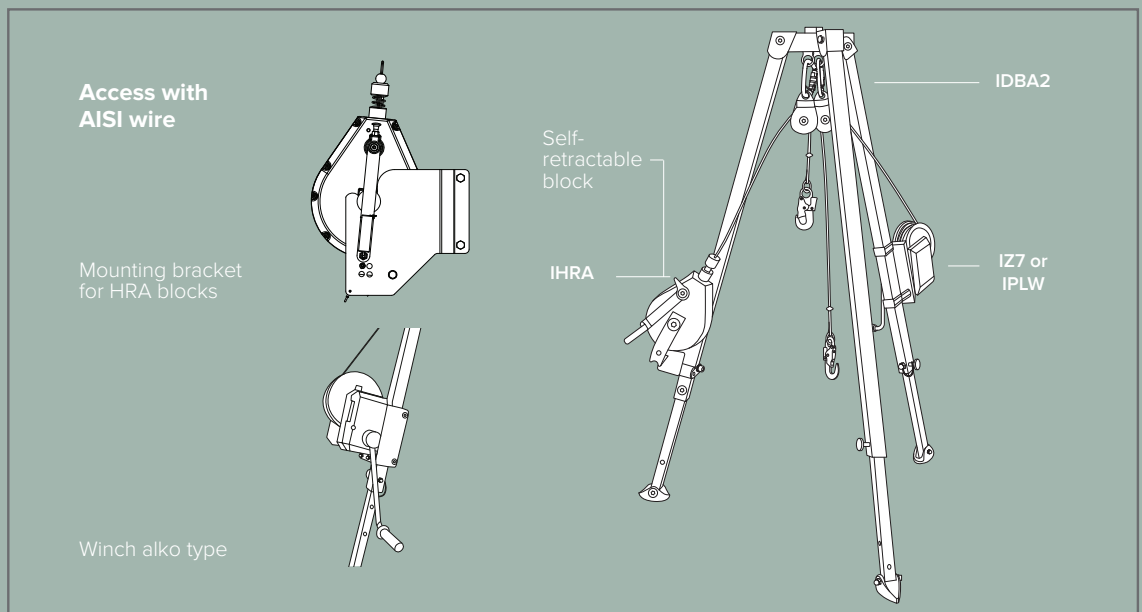
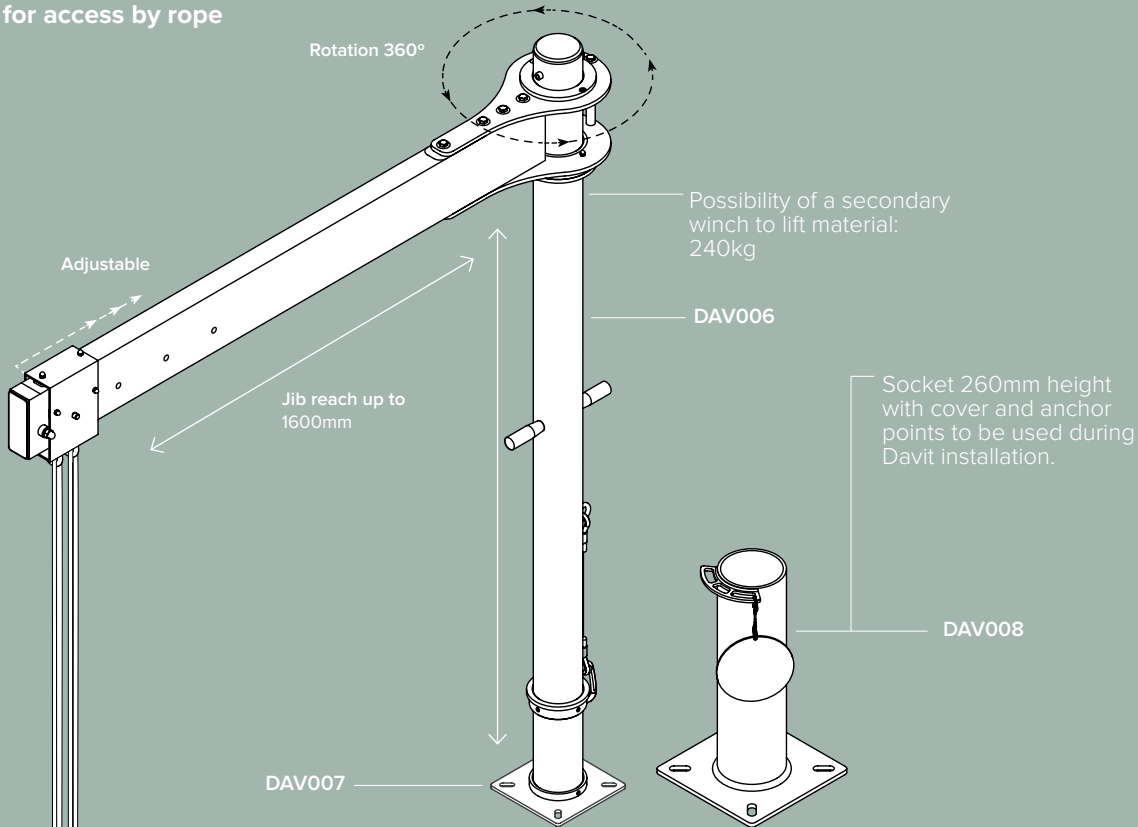

Fall protection & access equipment

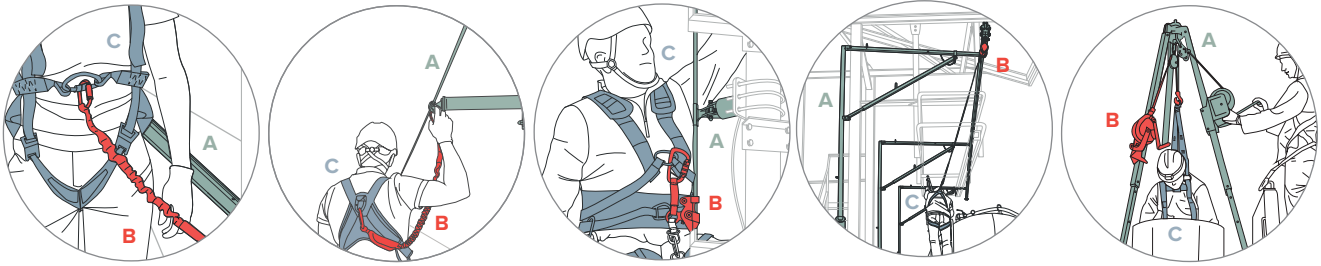

A

Anchorage

Structure capable of supporting 6kN per user attached as part of a complete personal fall arrest system which maintains a safety factor of at least two.

Fallprotec lifeline systems:

- 1) SecuRail Rail Lifeline: Maintenance of Flare tip/ Stack and mobile cranes.
 - 2) SecuRope overhead Cable Lifeline: Maintenance of machinery, fire and gas detectors.
 - 3) SecuRope Vertical Cable Lifeline: Access to the derrick, mobiles cranes and the platform deck.
 - 4) SafeAccess fall arrest: loading tanker trucks.
 - 5) Davit arm and tripods: Access to confined spaces.
- All systems are suitable for intensive use in complex industrial environments. Its components are reliable and durable.

Fixing brackets:

Fallprotec's internal engineering department offers bespoke fixation assemblies, adapted to various beam sizes and distances between them and walkways.

B

Connecting Devices

PPE Equipment with energy-absorbing element to reduce the energy transmitted to the user's body in the event of a fall. Products such as shock absorbing lanyards or self-retracting lifelines connect a worker's harness to the anchorage.

Fallprotec PPE:

- 1) Elastic single and double lanyards of 1,5m or 2m length.
- 2) Self-retractable fall arresters from 2 - 65m length, with aluminium casing, webbing strap or galvanised steel rope.

C

Body Support

A safety harness is a personal protective equipment (PPE) that is designed to catch a person in the event of a fall while working at height. Our full body harness distributes fall arrest forces across the shoulders, thighs and pelvis.

Two anchor points harness type V34 Explorer Offshore.

Body support - Harnesses



**Harness V34
Explorer Offshore**

EN361:2012



x 1

KG

150

Seawater resistant stainless steel hardware. Comfortable for the user.

Connecting devices - PPE



Available with webbing strap or galvanised steel cable. The spring mechanism keeps a constant tension on the lanyard, facilitating the movement of the user. Certified for ceiling, wall and ground configuration; enable the user to reach areas further away from the lifeline.

The overspeed system stops a fall in a very short distance. The integrated energy absorption mechanism ensures that the maximal force transmitted to the end user is 6kN.

They can stop a fall within the first centimeters while absorbing the energy of it. Combined with SafeAccess, it is the safest fallarrest system by minimum fall clearance.

Complete range of self retractable lanyard with aluminium casing and galva steel rope.

IHWS

EN354/355/362



x 1

KG

3,70

Connecting devices - PPE



Elastic lanyard 2m, energy absorber fitted with pivoting carabiner and hook 60mm opening

HAR076



Single lanyard 2 m with energy absorber and 2 twist lock carabiners opening 20mm





HAR010







Double elastic lanyard 2m with energy absorber Material 2 carabiners opening 60 mm in alu+ 1 automatic carabiner in zinc plated steel

HAR077





EN354/355/362

 x 1	 0,60	 2m
 x 1 20mm opening Aluminium	 x 1 60mm opening Aluminium	

EN354/355/362

 x 1	 0,50	 2m
 x 2 20mm opening Zinc plated steel		

EN354/355/362





 x 1	 0,80	 2m
 x 1 20mm opening Zinc plated steel	 x 2 60mm opening Aluminium	



Double lanyard 1,5 m fitted with energy absorber and 3 twist lock carabiner opening 20mm

HAR016

EN354/355/362

 x 1	 0,79	 1,5m
 x 3 20mm opening Zinc plated steel		

Fallprotec's products installations in oil & gas industry

Fallprotec's internal engineering department had offered bespoke solutions for many industrial sites, while working with a worldwide network of specialized installers, in order to master the complete process of securing plants against the risk of fall.

The scope of offered services includes risk assessments, site surveys, engineering, installation, commissioning, inspection and maintenance.

[Click here to view more case studies worldwide on our website](#)



📍 Offshore platform
Vlissingen Port, Netherlands



📍 Technip FMC
Tarragona, Spain

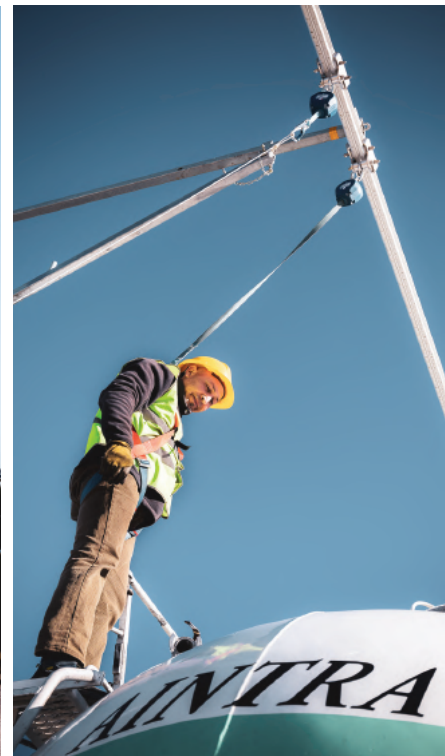

📍 Gas Plus
Parma, Italy



📍 Toll offshore platform
Singapore, Singapore

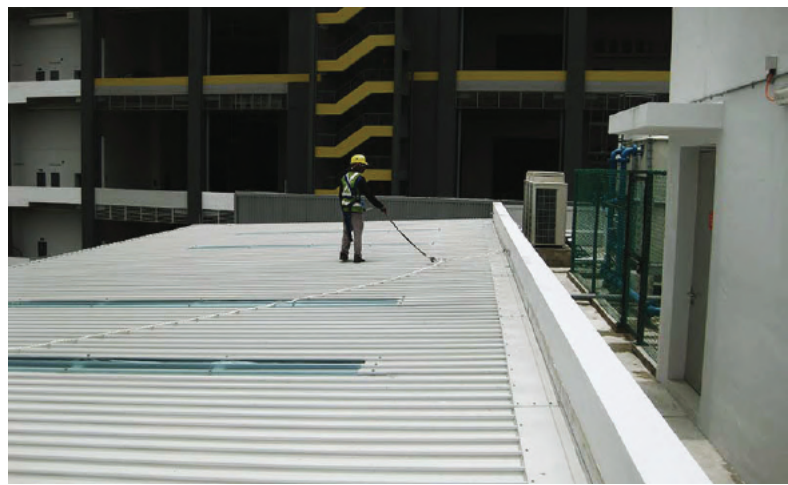

📍 GTLE
Lyon, France



📍 Repsol
Tarragona, Spain



📍 Centrale Gasificazione Roma
Rome, Italy



📍 Offshore platform
Netherlands



FALLPROTEC SA

43-45 ZA Op Zaemer
4959 Bascharage
Luxemburgo
T: +352 26 55 09 30
F: +352 26 55 09 30 55
marketing@fallprotec.com

FALLPROTEC SA

Eduard Calvet i Pintó 4
Pol. Ind. Vallmorena
08339 Vilassar de Dalt
España
T: +34 93 114 22 31
info@fallprotec.es

FALLPROTEC LATAM

Avda. Alcalde Carlos
Valdovinos 2199
Santiago de Chile
Región Metropolitana
T: +56 2 2512 6133
latam@fallprotec.com

FALLPROTEC CHINA

Room 213, Building 6
No. 398, Jinglian Road
Minhang District
Shanghai, China

T: +86 21 3126 8606
F: +86 21 2281 0168

+352 26 55 09 30
www.fallprotec.com

Follow us

fallprotec |    

FALLPROTEC

—
Height Safety Products

